

---

# USER MANUAL

## CareAssist™ Bed

From Hill-Rom



Product No. P1170

© 2005 by Hill-Rom Services, Inc. ALL RIGHTS RESERVED.

**Manufactured by:**

HILL-ROM COMPANY, INC.  
1069 STATE ROUTE 46 E  
BATESVILLE, IN 47006-9167

**Authorized European Union Representative:**

HILL-ROM SAS  
B.P. 14 - Z.I. DU TALHOUE  
56330 PLUVIGNER  
FRANCE  
TEL: +33 (0)2 97 50 92 12

No part of this text shall be reproduced or transmitted in any form or by any means, electronic or mechanical, including photocopying, recording, or by any information or retrieval system without written permission from Hill-Rom Services, Inc. (Hill-Rom).

The information in this manual is confidential and may not be disclosed to third parties without the prior written consent of Hill-Rom.

Fourth Edition

First Printing 2003

Printed in the USA

CareAssist™ is a trademark of Hill-Rom Services, Inc.

CSA® is a registered trademark of Canadian Standards Association, Inc.

Dining Chair™ is a trademark of Hill-Rom Services, Inc.

FullChair® is a registered trademark of Hill-Rom Services, Inc.

Hill-Rom® is a registered trademark of Hill-Rom Services, Inc.

Line-of-Site® is a registered trademark of Hill-Rom Services, Inc.

PLEUR-EVAC® is a registered trademark of Deknatel, Inc.

Shearless Pivot® is a registered trademark of Hill-Rom Services, Inc.

SideCom® is a registered trademark of Hill-Rom Services, Inc.

Slo-Blo® is a registered trademark of Littlefuse, Inc.

The UL logo is a registered trademark of Underwriter's Laboratories, Inc.

The information contained in this manual is subject to change without notice. Hill-Rom makes no commitment to update or keep current, the information contained in this manual.

Hill-Rom reserves the right to make changes without notice in design, specifications, and models. The only warranty Hill-Rom makes is the express written warranty extended on the sale or rental of its products.

To order additional copies of this manual (USR116), refer to the back cover for contact information. For countries not listed on the back cover, contact your distributor.

**NOTE:**

The back cover is a comprehensive list of Technical Support contact information for Hill-Rom. The product discussed in this manual may not be available in all of the countries listed.

<b>Revision</b>	<b>Pages Affected</b>	<b>Date</b>
Original Issue		October 2003
A	All	January 2004
B	All	January 2005
4	All	July 2005

---

---

## Table of Contents

Document Symbols	5
Intended Use	6
Introduction	6
Features	7
Standard Features	8
Emergency CPR Control	8
Caregiver Siderail Controls	8
Enable Control	8
Lockout Control	9
Bed Up/Down Control	9
Head Up/Down Control	10
Automatic Contour Feature	10
Knee Up/Down Control	11
Trendelenburg and Reverse Trendelenburg Controls	11
Bed Flat Control	11
Dining Chair™ Position	12
FullChair® Patient Positioning Mechanism	12
Vascular Position	13
Battery Control	13
Standard Casters	13
Brake and Steer Control	14
Head and Foot Siderails	14
Headboard	15
Footboard	16
Patient Position Indicator	16
Equipment Sockets	16
Foot Extension	17
Drainage Bag Holders	17
Patient Restraint	18
Standard Patient Controls	18
Optional Features	19
SideCom® Communication System	19
Nurse Call Control	19
Bed Exit System (Beds without Scale)	20
Bed Exit System (B Model Beds with Scale)	20
Bed Exit Alarm System (C Model and Newer Beds)	21
Scale (B Model and Newer Beds)	24
Bed Setup	24

Scale Display On/Off	24
Zero the Scale	24
Weigh the Patient	24
Changing Items on the Bed	25
Manual Weight Adjustment	25
Pounds/Kilograms	25
Optional Patient Controls	25
Nurse Call Control	25
Room Light Control	25
Reading Light Control	25
Volume Control	26
Channel Control	26
Music Control	26
Television Control	26
Accessories	27
IV Pole (P2217)	27
Mattress Foot Pad Extender (P734EA1)	28
Infusion Support System Transfer Pole (P158)	28
Mattress (P731EA3)	28
Oxygen Tank Holder, E-Size (P27601)	29
Traction Frame Support (P1181)	29
Patient Helper Support (P1180)	29
Safety Tips	30
Bed Positions	30
Brakes	30
Siderails/Restraints/Patient Monitoring	30
Electricity	31
Parts and Accessories	32
Operating Bed/Surface Precautions	32
Transport	32
Sleep Surface/Mattress	33
Flammability	33
Bed Articulations	34
Chair Positioning	34
Visitor Notification	34
Cleaning	35
General Cleaning	35
Steam Cleaning	35
Cleaning Hard to Clean Spots	35

Disinfecting .....	35
Preventive Maintenance .....	36
The CareAssist™ Bed Main Battery .....	36
Troubleshooting .....	36
Product Symbols .....	37
Specifications .....	45

---



---

## Document Symbols

This manual contains different typefaces and icons designed to improve readability and increase understanding of its content. For a list of symbols used on the product, see “Product Symbols” on page 37.

Note the following examples:

- Standard text—used for regular information.
- **Boldface text**—emphasizes a word or phrase.
- **NOTE:**—sets apart special information or important instruction clarification.
- The symbol below highlights a **WARNING** or **CAUTION**:

### Warning and Caution



- A **WARNING** identifies situations or actions that may affect patient or user safety. Disregarding a warning could result in patient or user injury.
- A **CAUTION** points out special procedures or precautions that personnel must follow to avoid equipment damage.
- The symbol below highlights a **CAUGHT HAZARD WARNING**:

### Caught Hazard Warning



- The symbol below highlights a **CHEMICAL HAZARD WARNING**:

### Chemical Hazard Warning



- The symbol below highlights an **ELECTRICAL SHOCK HAZARD WARNING**:

### Electrical Shock Hazard Warning



---

## **Intended Use**

The CareAssist™ Bed is intended for low to moderate acuity patients in the medical/surgical area of the hospital.

---

## **Introduction**

This manual provides the information required for normal operation of the CareAssist™ Bed from Hill-Rom. Before operating the CareAssist™ Bed, be sure that you have read and understood in detail the contents of this manual. It is important that you read and strictly adhere to the aspects of safety contained in this manual. Any reference to a side of the bed is from the view of the patient lying in the supine position.

## Features

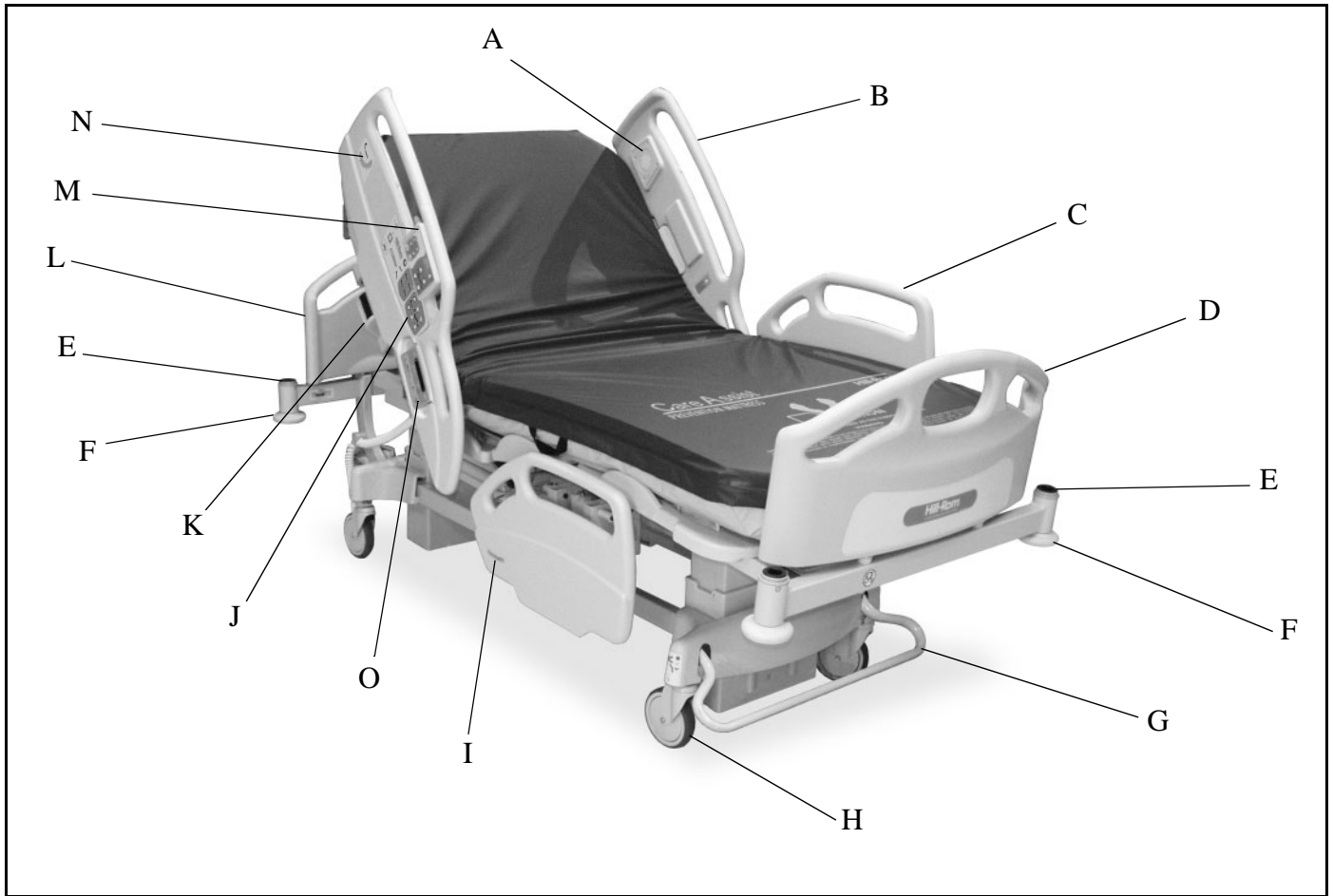

Item	Description	Item	Description
A	Speaker	H	6" (152 mm) caster
B	Head siderail	I	Trendelenburg/Reverse Trendelenburg Line-of-Site® Angle Indicator
C	Foot siderail	J	Caregiver siderail controls
D	Footboard	K	Siderail release mechanism
E	Equipment socket	L	Headboard
F	Wall guard	M	Patient control pendant
G	Brake/steer bar	N	Line-of-Site® Head Angle Indicator
		O	Scale control pod (B model and newer beds)

---

## Standard Features

---

### Emergency CPR Control

The Emergency CPR control handles are located at the head end of the bed, under each corner of the sleep deck.

When activated, the CPR release allows the head section to lower. The CPR release function is gas-assisted to cushion the movement and can be used when power is not available.

#### To Activate

- Pull, and hold, the CPR control handle with one hand.
- Let the head section come to a stop in the flat position.
- Release the CPR control handle when the head section is flat.

The head section actuator is automatically re-enabled after the CPR control handle is released.

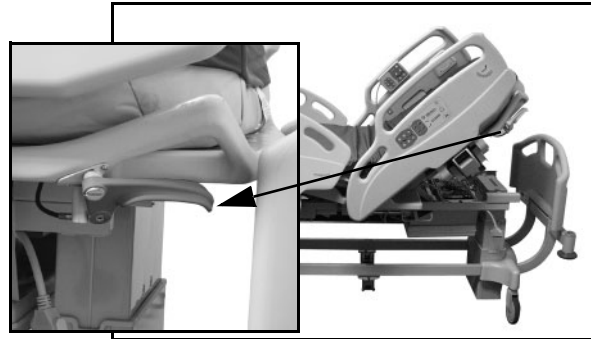

---

### Caregiver Siderail Controls

The caregiver siderail controls are located on the outside of the head siderails.



---

### Enable Control

The Enable control deters unauthorized operation of certain siderail controls. The Enable control must be pressed before the Trendelenburg and Reverse Trendelenburg controls will operate. The Enable control stays active for approximately 60 seconds.



#### To Activate

- Press the *Enable* control. The Enable control is active for approximately 60 seconds.
- During the 60-second period, you may activate the Trendelenburg and Reverse Trendelenburg controls without pressing the Enable control again.

The following caregiver controls can be activated without activating the Enable control: Bed Up/Down, Head Up/Down, Knee Up/Down, Nurse Call, Chair Positioning, Foot Up/Down, and Bed Flat.

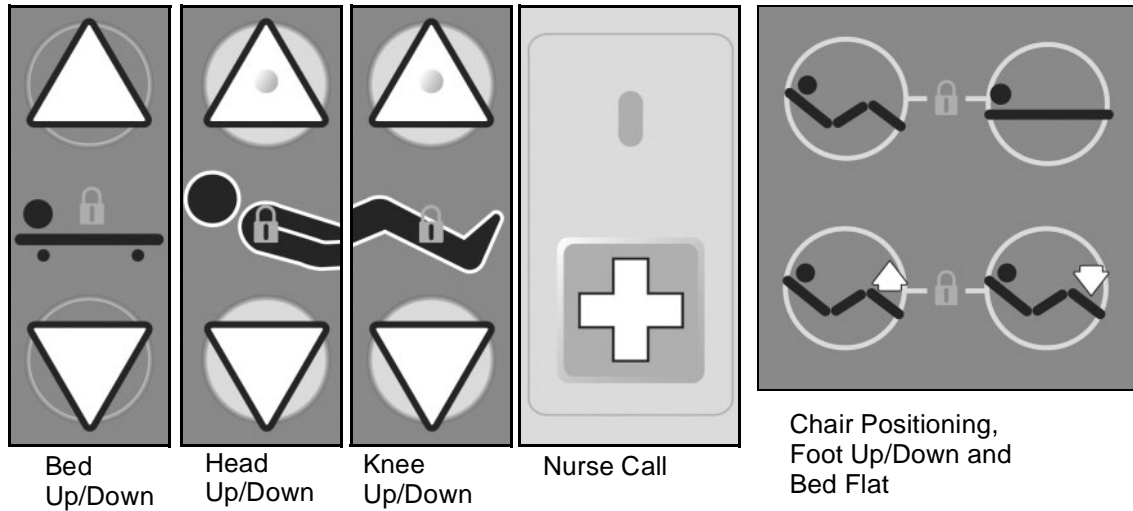

## Lockout Control

The Lockout control, located on the caregiver siderail control panel, disables the bed articulation functions. The Lockout control affects only the functions inside the blue area of the caregiver siderail control panel.



### To verify a previously locked out control is properly disabled

Check both siderails to ensure the LED for the locked control is illuminated. If one lockout is illuminated, and one is not illuminated, activate the control to verify the control is locked out, then contact your facility maintenance personnel.

### To Activate

- Press and hold the Lockout control, and then press the desired control. Both patient and care-giver controls are locked out. An LED on the control panel illuminates continuously when a lockout is activated.
- After the desired control is locked out, activate the locked out control to verify the lockout is activated. If the desired control is not locked out, contact your facility maintenance personnel.

### To Deactivate

Press and hold the *Lockout* control, and then press the locked out control.

The Lockout control disables only **articulation** controls, not Nurse Call. No movement of the unit is allowed, except for emergency CPR, Trendelenburg, and Reverse Trendelenburg.

## Bed Up/Down Control

The CareAssist™ Bed adjusts in height from a low position for patient egress to a high position for examination. The Bed Up/Down controls are located on the head siderails.

### To Activate

- Press and hold the *Bed Up* control to raise the bed. Release the control when the desired height is reached.
- Press and hold the *Bed Down* control to lower the bed. Release the control when the desired height is reached.

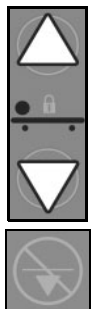

- To disable the Bed Up/Down control activate its *Lockout* control.

**NOTE:**

When the bed is **not** in the low-low position, an indicator next to the Up/Down control illuminates.

**⚠ WARNING:**

When raising the bed, ensure there is sufficient room above the IV pole/ISS pole if installed. Failure to do can result in patient injury.

## Head Up/Down Control

Using the Head Up/Down controls, the caregiver can adjust the head section to specific angles. The Line-of-Site® Angle Indicators are located on the head siderails.

The head section maximum travel is 65°.

**To Activate**

- Press and hold the *Head Up* control to raise the head section.
- Press and hold the *Head Down* control to lower the head section.

**NOTE:**

The CareAssist™ Bed is equipped with an automatic contour feature. When the Head Up control is pressed, the automatic contour feature is enabled, and the knee section rises to an intermediate position (20°).

- Automatic Contour Feature—Press and hold the *Head Up* control. The head and knee sections rise together to reduce patient migration toward the foot end of the bed.
- Disable Automatic Contour—Press and hold the *Knee Down* control while raising the head section, or activate the Knee Lockout control.



## Automatic Contour Feature

The automatic contour feature (automatic comfort level positioning) can be activated by using the Head Up control.

The automatic contour feature raises the head section and the knee section simultaneously and helps to prevent the patient from sliding down in the bed.

To avoid patient sliding while lowering the head section, the knee section will stay elevated until the head section reaches the flat position.

The automatic contour feature is active only when both the head section and knee section are not locked out.

**NOTE:**

When the head section is locked out, the knee section can be raised or lowered by using the Knee Up/Down control.

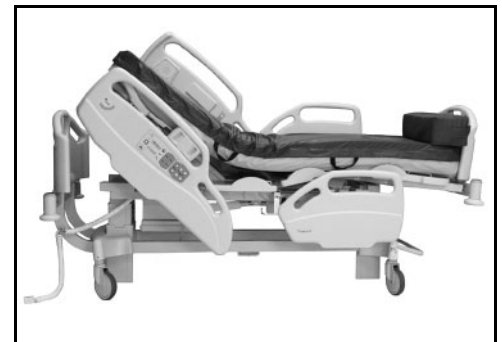

---

## Knee Up/Down Control

The caregiver can raise or lower the knee section by using the Knee Up/Down controls. The knee section has a maximum travel of 35°.

### To Activate

- Press and hold the *Knee Up* control to raise the knee section.
- Press and hold the *Knee Down* control to lower the knee section.

The automatic contour feature does not work when using only the Knee Up/Down controls.



---

## Trendelenburg and Reverse Trendelenburg Controls

The CareAssist™ Bed is capable of a 16° Trendelenburg and 16° Reverse Trendelenburg. The powered Trendelenburg and Reverse Trendelenburg controls can be activated at any bed height.

The Trendelenburg and Reverse Trendelenburg Line-of-Site® Angle Indicators are located in the foot end siderails.

### To Activate

- Press the *Enable* control.
- Press and hold the *Trendelenburg* control to go into the Trendelenburg position. The foot end of the bed system articulating frame raises relative to the head end.
- Press and hold the *Reverse Trendelenburg* control to go into the Reverse Trendelenburg position. The head end of the bed system articulating frame raises relative to the foot end.
- Press the opposite control to return to the flat position. (If in the Trendelenburg position, press *Reverse Trendelenburg*. If in the Reverse Trendelenburg position, press *Trendelenburg*.)

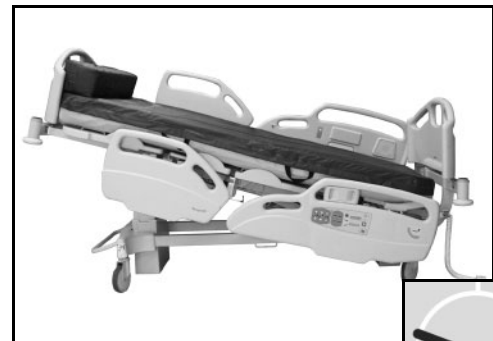

Trendelenburg

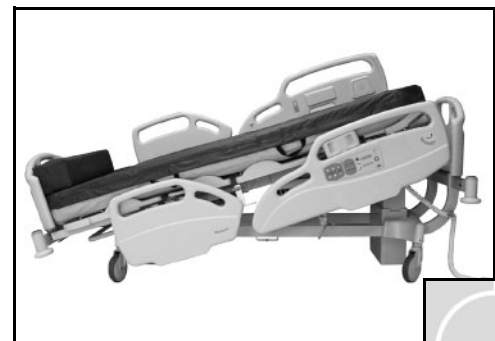
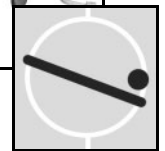

Reverse Trendelenburg

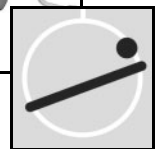

---

## Bed Flat Control

The Bed Flat control is provided so that a caregiver can easily return the sleep deck to a flat position (head and knee section down and foot section up) from any articulated position. The Bed Flat control only returns the sleep deck to a flat position, it **does not** change the angle of the bed. The Bed Flat control **does not** lower the foot section if it is raised (vascular position).

### To Activate

Press and hold the *Bed Flat* control. When all sections are flat, the system stops.

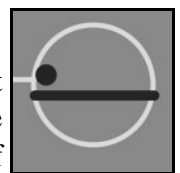

---

## Dining Chair™ Position

The Dining Chair™ Position control allows the caregiver to put the bed in an upright position.

The Dining Chair™ Position controls are located on the outside of the head siderails. When activated, the bed will articulate to a maximum of 65° for the head section, 20° for the knee section, and -23° for the foot section.

### **⚠ WARNING:**

Check periodically to make sure the patient remains properly positioned. The use of pillows can help maintain side-to-side positioning. Injury to the patient may result from improper positioning.

#### **To Activate**

- Set the brake.
- Press the *Dining Chair™ Position* control. The patient deck moves to the chair position.

#### **To Return to Flat Position**

Press the *Bed Flat* control to return the sleep deck to the flat position.



---

## FullChair® Patient Positioning Mechanism

The FullChair® Patient Positioning Mechanism allows the caregiver to place the patient in a fully seated position without having to remove the patient from the bed.

### **⚠ WARNING:**

Check periodically to make sure the patient remains properly positioned. The use of pillows can help maintain side-to-side positioning. Injury to the patient may result from improper positioning.

#### **To Activate**

- Set the brake.
- Press the *Dining Chair™ Position* control. The patient deck transitions to the chair position.
- Once the bed has finished traveling, press the *Enable* control.
- Press the *Reverse Trendelenburg* control until the desired position is obtained.

#### **To Return to Flat Position**

- Press the *Bed Flat* control to return the sleep deck to the flat position.
- Press the *Trendelenburg* control to return the bed frame to the level position.





---

## Vascular Position

The Vascular Position allows the caregiver to place the patient's legs above the level of the patient's sternum without placing the bed in the Trendelenburg position.

### To Activate

- Raise the knee section to 20° or more.
- Press the *Foot Up* control.
- Adjust the knee section as needed to maintain alignment with the foot section.

### To Return to Flat Position

Press the *Foot Down* control.

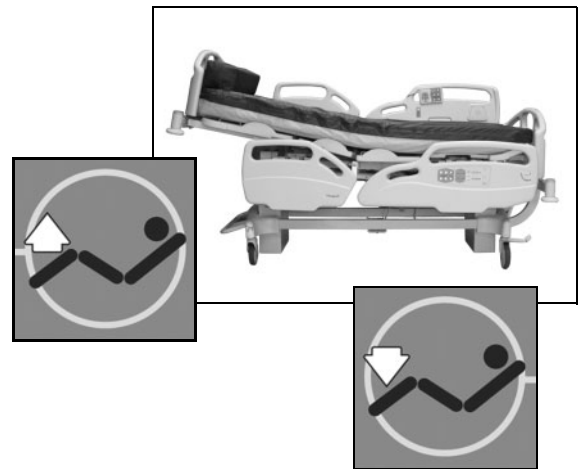

---

## Battery Control

The battery function is **available only** when the bed is **not connected** to AC power.

Press the *Battery* control to activate the battery. All patient comfort electrical functions are then available.

When the battery charge level is low and an electrical function is activated, an alarm will sound indicating that the battery needs recharging. The ongoing bed movement will be completed.

Plug the bed into an appropriate power source to automatically charge the battery.



### ⚠ WARNING:

The bed must remain connected to the mains power supply until the charge LED turns off (recharge time is approximately 10 hours, for a completely discharged battery). Failure to do so could result in the inability to operate the bed when power is unavailable.

If the indicator is flashing, it indicates a low battery, and is charging. If the indicator is not illuminated and AC power is connected, the battery is fully charged. When disconnected from AC power, the indicator will not be illuminated.

---

## Standard Casters

The CareAssist™ Bed is equipped with 6" (152 mm) single wheel casters.

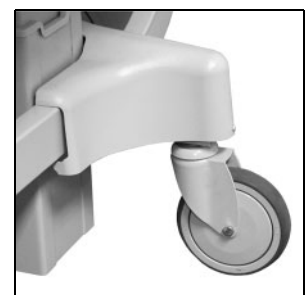

---

## Brake and Steer Control

### **⚠ WARNING:**

Unless transporting the patient, always set the brakes when the unit is occupied. Reconfirm that the brakes are set before any patient transfer. Failure to do so may result in personal injury or equipment damage.

The brake and steer control is located under the foot section. There are three positions: Brake, Neutral, and Steer. The brake position keeps the bed from moving. The neutral position allows the bed to be moved sideways. The steer position allows the bed to be moved in a straight line.

When the bed is plugged into AC power and the brakes are not set, an alarm sounds until the brakes are set or AC power is removed.

### **To Activate**

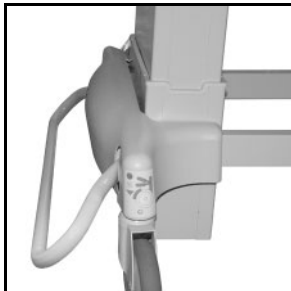

#### **Brake**

Using your foot, step down on the brake/steer bar until it stops.

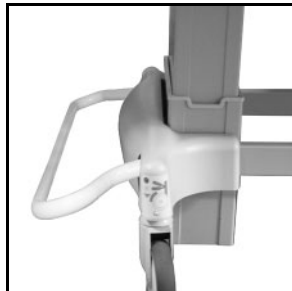

#### **Neutral**

Using your foot, lift the brake/steer bar until it travels to the middle detent.

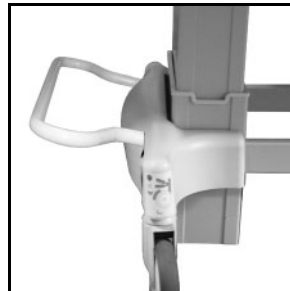

#### **Steer**

Using your foot, lift the brake/steer bar to the full up position.

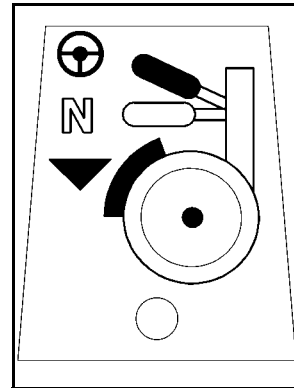

#### **Brake Position Label**

Located on the base frame near the casters.

---

## Head and Foot Siderails

### **⚠ WARNING:**

Evaluate patients for entrapment risk according to facility protocol, and monitor patients appropriately.

### **⚠ WARNING:**

Evaluate patients for entrapment risk according to facility protocol, and monitor patients appropriately. Ensure that all siderails are fully latched when in the raised position. Failure to do either of these could result in serious injury or death.

#### **NOTE:**

Siderails are intended to be a reminder to the patient of the unit's edges, not a patient-restraining device. When appropriate, Hill-Rom recommends that medical personnel determine the proper methods necessary to ensure a patient remains safely in bed.

The CareAssist™ Bed siderails have been designed for one-step operation.

Siderails in the raised position are intended to make the patient aware of the proximity of the edge of the sleep surface and to assist in patient entry and exit.

Siderails in the lowered position, below the patient surface, facilitate a patient's entry or exit from the bed. This design feature also facilitates unobstructed access to the patient.

The head siderails contain the Line-of-Site® Head Angle Indicators and the foot siderails contain the Line-of-Site® Trendelenburg Angle Indicators.

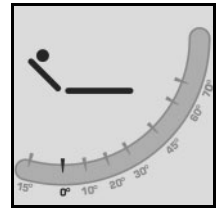
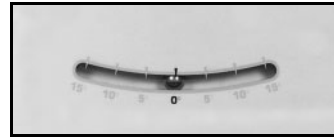

### To Raise a Siderail

- Pull the siderail up until it latches into the locked position. A **click** will be heard when it latches into the locked position.
- Once the **click** is heard, gently pull on the siderail to ensure it is latched properly.

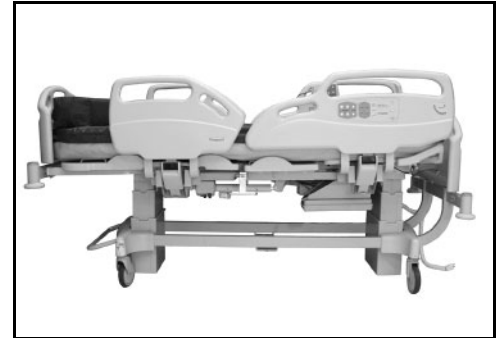

### To Lower a Siderail

Grasp the release handle and pull up. The siderail lowers automatically.

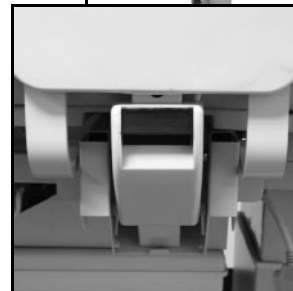
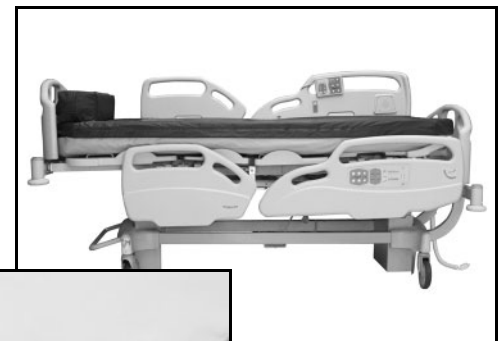

---

## Headboard

The headboard is located at the head end of the bed. It attaches to the head end of the frame. It **does not** articulate with the sleep deck.

The headboard can be removed for increased access to the patient's head without the use of tools.

### To Remove

Grasp the headboard, and lift it straight up.

### To Install

- Position the headboard pins over the sockets in the frame.
- Lower the headboard into the sockets.
- Push the headboard down until the bottom rests on the frame.



---

## Footboard

The footboard is located at the foot end of the bed. It attaches to the articulating foot section and remains perpendicular to the surface of the foot section at all times. The footboard protects the patient during transport and room docking.

A caregiver can quickly remove or attach the footboard in a single step without the use of tools.

### To Remove

Grasp the handles on the footboard, and lift it straight up.

### To Install

- Insert the pins of the footboard into the sockets in the articulating frame.
- Push the footboard down until it rests on the deck.



---

## Patient Position Indicator

The patient position indicator is located on the inside of the head siderails. The indicator is used to help provide optimal, ergonomic patient positioning.

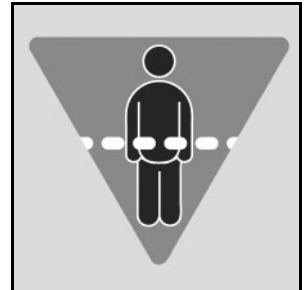

---

## Equipment Sockets

There are four equipment sockets, one at each corner, for the attachment of accessories.

The equipment sockets can be used to mount IV poles, ISS poles, traction equipment, and oxygen tank holders.

### NOTE:

The ISS poles require an adapter to be installed prior to use. See “Accessories” on page 27.

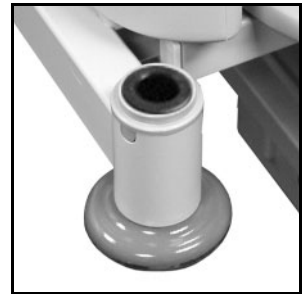

---

## Foot Extension

The foot extension allows the foot section to extend 4" (10 cm).

### To Extend the Foot Section

- Grasp the control bar located under the bed frame, below the footboard.
- Push up on the control bar.
- Pull the foot section out, then release the control bar.
- Continue to pull on the foot section until it locks into position.
- When the foot section is extended, insert the mattress foot extender pad between the mattress and the footboard.

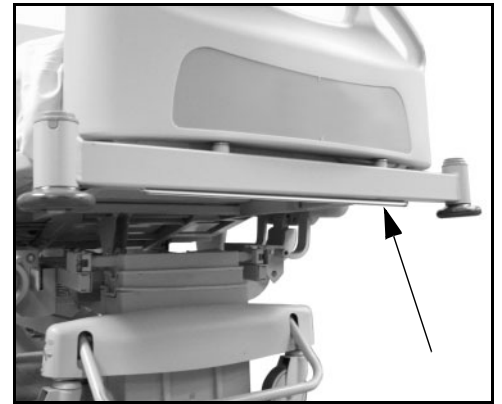

### To Retract the Foot Section

- Remove the mattress foot extender pad.
- Grasp the control bar located under the bed frame, below the footboard.
- Push up on the control bar.
- Push the foot section toward the head end of the bed, then release the control bar.
- Push the foot section in until it locks into position.

---

## Drainage Bag Holders

### ⚠ WARNING:

Do not tie restraints to the primary drainage bag holders.

There are two drainage bag holders mounted on the bed, just under the sleep deck surface.

### ⚠ WARNING:

Caregivers should select drainage system components that can be safely used within infection control and other therapeutic guidelines. Failure to do so could cause patient injury.

The holders accommodate any combination of the following drainage devices:

- Fecal incontinence bag
- 250/2000 ml Foley collection bag
- PLEUR-EVAC®<sup>1</sup> (on foot end holders during transport only)

When the bed system is docked, place the PLEUR-EVAC® or other chest drainage devices on the floor, clear of the bed system to allow space for articulation.

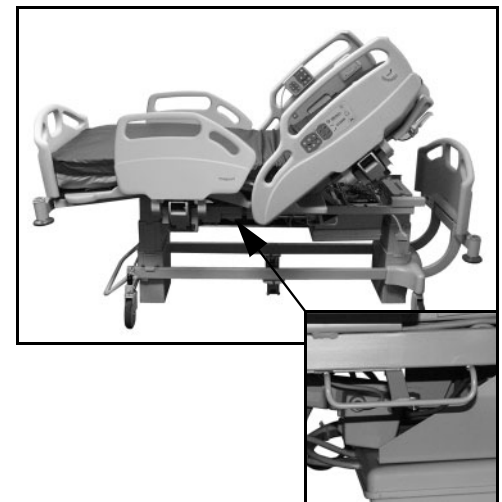

---

1. Pleur-Evac® is a registered trademark of Deknatel, Inc.

---

## Patient Restraint

The CareAssist™ Bed facilitates the use of vest, wrist, waist, and ankle restraints. Hill-Rom makes no recommendation regarding the use of physical restraints. Caregivers should refer to legal restrictions and appropriate facility protocols before physical restraints are used.

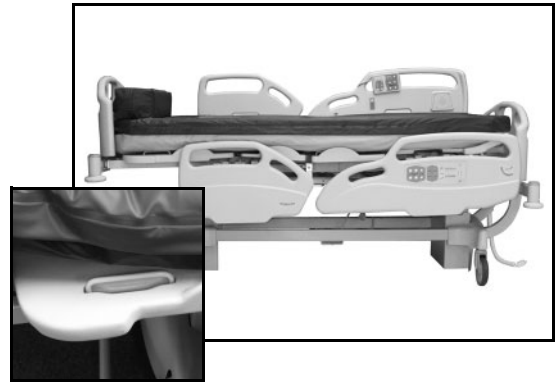

### ⚠ WARNING:

Patient restraints are not intended as substitutes for good nursing practices. Physical restraints, even properly installed, can result in entanglement, physical injury, and death, particularly with agitated and disoriented patients. Monitor patients when using physical restraints in accordance with legal requirements and facility protocol.

### ⚠ WARNING:

Restraints must be attached to the articulating sections of the system at the proper attachment points to prevent injury to the patient.

### ⚠ WARNING:

Do not use ankle restraints in a chair position or when the foot section is retracted. Doing so may result in patient injury or equipment damage.

---

## Standard Patient Controls

The patient controls are located on the patient pendant, which can be housed in any siderail.

The standard patient controls include: Head Up/Down and Knee Up/Down. They operate in the same manner as the caregiver siderail controls.

If the caregiver has locked out a bed function, that same function is locked out on the patient control pendant.



### To Install the Pendant into the Siderail

- Position the pendant next to the opening in the siderail.
- Insert the top edge of the pendant into the siderail so it engages the upper section of the siderail.
- Rotate the lower edge of the pendant in until it **clicks** into place inside the siderail.

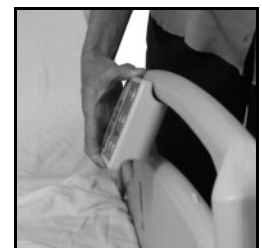

### To Remove the Pendant from the Siderail

Gently pull on the lower edge of the pendant until it pops out of the siderail.

To move the pendant from one siderail to the other, the control cable mount must be moved from one side of the bed to the other. It is recommended to have facility maintenance personnel perform this procedure.

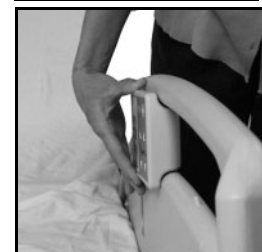

## Optional Features

### SideCom® Communication System

The SideCom® Communication System provides the following controls: Nurse Call, Entertainment, and Lighting.

The SideCom® Communication System connector is located at the head end of the bed. When not connected to the facility, install the dummy plug onto the bed SideCom® Communication System cable.

A Model Bed

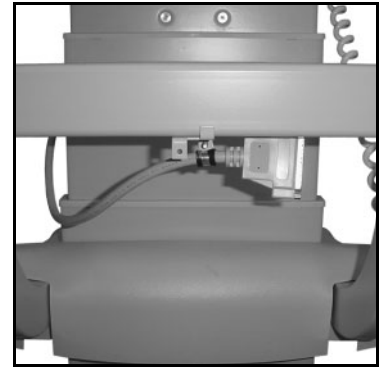

B Model and Newer Beds

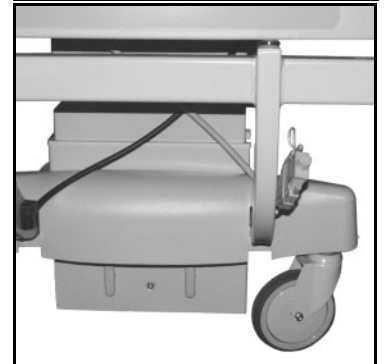

### Nurse Call Control

The Nurse Call control is located on the outside and inside of the head siderails.

When the Nurse Call control is activated, and connected to the facility, a signal is sent to the nurses station, and an LED illuminates on the control. Voice communication is provided through a speaker/microphone mounted on the inside of both head siderails.

#### To Activate

- Press a *Nurse Call* control.
- When the nurses station acknowledges the nurse call, the LED on the Nurse Call control will flash.
- When the nurses station's communication line is open, the LED stops flashing and illuminates continuously.
- Speak into the speaker/microphone located on the inside of the head siderails.

#### NOTE:

The Enable control **does not** need to be activated prior to pressing a Nurse Call control. The Nurse Call controls are always active. The Nurse Call controls cannot be locked out.

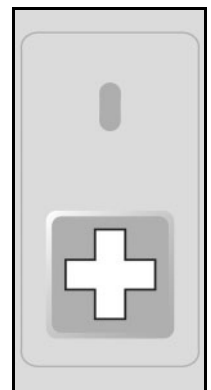

---

## Bed Exit System (Beds without Scale)

### ⚠ WARNING:

The Bed Exit System is not intended as a substitute for good nursing practices. The Bed Exit System must be used in conjunction with a sound risk assessment and protocol.

The Bed Exit system is designed to be a reminder to the patient to stay in bed. The Bed Exit control is located on the outside of both head siderails.

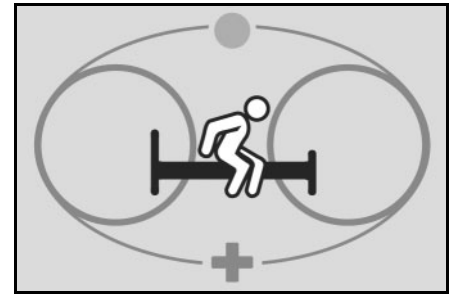

### To Activate

- Ensure the patient is on the bed.
- Simultaneously press **both** buttons on the *Bed Exit* control on either head siderail. The LED will illuminate when armed.

When activated, the Bed Exit sounds a local alarm when the patient exits the bed. If the bed is equipped with the SideCom® Communication System, and it is connected to the facility, a signal is sent to the nurses station when the Bed Exit alarm sounds.

If the patient moves to exit the bed, the Bed Exit alarm sounds. If the Nurse Call system is operational, a signal is sent to the nurse station. The Bed Exit system must be turned off at the bedside to cancel the nurse call signal.

### To Reset After the Alarm Sounds

- Ensure the patient is on the bed.
- Simultaneously press **both** buttons on the *Bed Exit* control on either head siderail to turn the system off.
- Simultaneously press **both** buttons on the *Bed Exit* control on either head siderail to turn the system on. The LED will illuminate when armed.

### To Deactivate

Simultaneously press **both** buttons on the *Bed Exit* control on either head siderail.

---

## Bed Exit System (B Model Beds with Scale)

### ⚠ WARNING:

The Bed Exit System is not intended as a substitute for good nursing practices. The Bed Exit System must be used in conjunction with a sound risk assessment and protocol.

The patient must weigh between 50 and 400 lb (23 to 181 kg) for Bed Exit to work.

### To Activate

- Press the *Enable* control on the scale control pod.
- Press the *Bed Exit* control. When the *Bed Exit* control indicator comes on, the Bed Exit is armed.



### NOTE:

The Enable control on the scale control pod does **not** activate the Trendelenburg or Reverse Trendelenburg controls.



When 30 lb (14 kg) are added to the bed, a warning tone sounds. When 30 lb (14 kg) are removed from the bed, a local alarm sounds. If the Nurse Call system is operational, a signal is sent to the nurse station. The Bed Exit system must be turned off at the bedside to cancel the nurse call signal.

### To Silence an Alarm

- Press the *Enable* control on the scale control pod.
- Press the *Bed Exit* control. This turns off the Bed Exit system and silences the alarm.
- Make sure the patient is on the bed.
- Activate the Bed Exit system.

### Changing the Alarm Tone

- Press the *Enable* control on the scale control pod.
- Press the *Tone* control until you reach the desired tone.

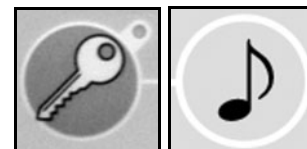

### Changing the Alarm Volume

- Press the *Enable* control on the scale control pod.
- Press the *Volume* control until you reach the desired volume. The volume setting is shown next to the *Volume* control.

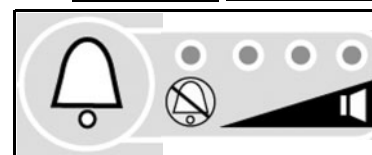

## Bed Exit Alarm System (C Model and Newer Beds)

### ⚠ WARNING:

The Bed Exit Alarm System is not intended as a substitute for good nursing practices. The Bed Exit Alarm System must be used in conjunction with a sound risk assessment and protocol.

The Bed Exit Alarm System control is on the flip-up control pod on the outside of the head end siderails.



The Bed Exit Alarm System has three modes: Patient Position Mode/Patient Movement Mode, Bed Exiting, and Out-of-Bed.

### Patient Position Mode/Patient Movement Mode

The Patient Position Mode/Patient Movement Mode alarms when the patient moves towards either siderail or moves away from the head section, such as sits up in bed. This mode should be used when a caregiver wants to be alerted when the patient begins to move. (Sometimes this is referred to as Patient Movement Mode).

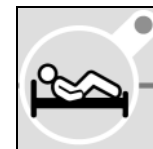

When the system is armed and it detects patient movement towards either siderail or away from the head section, these occur:

- An audible alarm comes on.
- The Patient Position Mode/Patient Movement Mode indicator flashes.
- A priority nurse call is sent. The light and alarm continue until the system is turned off, even if the patient lies down on the bed.

## Bed Exiting Mode

The Bed Exiting Mode alarm comes on when a patient moves away from the center of the bed towards an egress point. This mode should be used when a caregiver wants to be alerted when a potential egress is attempted.



When the system is armed and it detects patient movement towards an exit point, these occur:

- An audible alarm comes on.
- The Bed Exiting Mode indicator flashes.
- A priority nurse call is sent. The light and alarm continue until the system is turned off, even if the patient lies down on the bed.

## Out-of-Bed Mode

The Out-of-Bed Mode alarm comes on when the patient's weight shifts significantly off the frame of the bed. This mode should be used when a caregiver wants the patient to move freely within the bed, but to be alerted when the patient leaves the bed.



When the system is armed and it detects movement off the bed, these occur:

- An audible alarm comes on.
- The Out-of-Bed Mode indicator flashes.
- A priority nurse call is sent. The light and alarm continue until the system is turned off, even if the patient lies down on the bed.

## To Activate

1. Make sure the patient is centered in the bed and aligned with the hip locator.
2. Press the *Enable* control until the indicator comes on.
3. Press the applicable mode control. When the system beeps one time and the indicator stays on solid, the system is armed.

### NOTE:

The indicator flashes until the system is armed.



Enable  
Control



Patient Position  
Mode/Patient  
Movement Mode



Bed Exiting Mode



Out-of-Bed  
Mode

If the system does not arm, the system will beep rapidly for a few seconds and the selected mode indicator will flash. This means the patient weighs less than 50 lb (23 kg) or more than 400 lb (181 kg), the patient is not in the correct position, or the system has malfunctioned.

## To Reset or Deactivate

1. Press the *Enable* control until the indicator illuminates.
2. Press any mode control, or the alarm silence control, until the indicator goes off.

## To Adjust the Alarm Volume

1. make sure the patient must be on the bed and the system is armed.
2. Press the *Enable* control until the indicator illuminates.
3. Press and release the *Volume* control until the applicable indicator illuminates next to the volume setting.

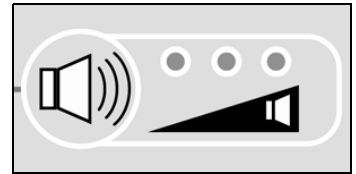

## To Change the Alarm Tone

1. Activate one of the Bed Exit Alarm System Modes. It is recommended to use another caregiver instead of a patient to activate the Bed Exit Alarm System mode.
2. Have the caregiver exit the bed to activate the alarm.
3. Press and hold the *Volume* control.
4. While you press the *Volume* control, press the *Out-of-Bed* control.
5. Press and release the *Out-of-Bed* control until the desired tone is reached.
6. Clear the alarm condition.

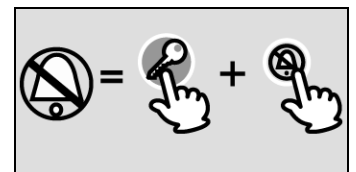
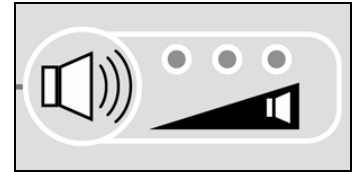

## Zero the Bed Exit Alarm System

The Bed Exit Alarm System must be zeroed before the patient is put on the bed. Be sure to put **all** linens, pillows, and equipment on the bed before you zero it.

### To Zero

1. Make sure the patient is **not** on the bed.
2. Press the *Enable* control.
3. Press and hold the *Zero* (0) control for 1 second. Release the control pod. When the system beeps, it is zeroed.

If all three Bed Exit Alarm System control indicators are flashing, zero the bed exit alarm system.

Scale Beds



Non-Scale Beds



## Maintenance Required Indicator

The maintenance required indicator notifies the caregiver when there is a problem with the **Bed Exit System only**. Contact the facility maintenance persons to fix the problem.



## Scale (B Model and Newer Beds)

The scale system for the CareAssist™ Bed has an accuracy of 1% or 2.2 lb (1 kg), whichever is greater and an operating range of 0 lb to 400 lb (0 kg to 181 kg). The scale display and controls are located on head end siderails.

The scale is very sensitive. The weight reading will be most accurate if the bed is not touching anything. This includes the headwall, lines such as pendant controls, ventilators, or drainage bags.

### Bed Setup

For best results, do as follows **before** you put the patient on the bed:

1. Make sure the bed is plugged into electrical power.
2. Put all linens, blankets, pillows, equipment, and other items on the bed. A list of these items posted near the bed may be helpful for future reference.
3. Make sure none of the items on the bed are touching the headboard.
4. Make sure the bed is not touching anything that could affect the patient weight (headwall, lines such as pendant controls, ventilators, or drainage bags).
5. Zero the scale, see “Zero the Scale” on page 24.

The scale system is now ready to weigh.

### Scale Display On/Off

Press the *Weigh* control. The scale display becomes active and shows 4 dashes "----," and the scale controls can be used. The scale display will automatically turn off after 3 minutes of no activity.



### Zero the Scale

The bed must be zeroed before the patient is put on the bed.

1. Make sure **all** linens, pillows, and equipment are on the bed.
2. Press the *Weigh* control. Wait for two beeps to sound.
3. Press and hold the *Zero* control until the *Hands Off* indicator flashes. The display will show 00.0.



### Weigh the Patient

1. Make sure of these:
  - All items defined in the “Bed Setup” section are accounted for.
  - No drainage bags or equipment has been added.
  - The patient is lying still and is centered on the mattress.
2. Press the *Weigh* control until the *Hands Off* indicator flashes. The weight will show in either pounds (lb) or kilograms (kg).



B-model beds



C-model and newer beds

## Changing Items on the Bed

The *Change Items* control lets you add or remove items from the bed. The control is active for 5 minutes once pressed.



1. Press the *Change Items* control until the *Hands Off* indicator flashes. The bed takes a reference weight reading.
2. When the *Change Items* indicator flashes, add or remove items as necessary.
3. Press the *Change Items* control after adding or removing the desired items. Release the display pod. The bed takes a weight reading and adjusts for the items added or removed.

## Manual Weight Adjustment

The plus and minus arrows let the caregiver manually put in a weight for the scale system.

Press and hold the *Plus* or *Minus* control to adjust the displayed weight.

## Pounds/Kilograms

Press the *lb/kg* control to change the display to show the weight in pounds (lb) or kilograms (kg).

---

## Optional Patient Controls

The optional patient controls are located on the patient pendant.



### Nurse Call Control

The Nurse Call control is located on the inside of the head siderails and on the patient pendant. The patient Nurse Call control functions in the same manner as the caregiver Nurse Call control (see “Nurse Call Control” on page 19).



### Room Light Control

The room light control allows the patient to turn the room light off and on.



### Reading Light Control

The reading light control allows the patient to turn the reading light off and on.



## Volume Control

The volume control allows the patient to adjust the volume of the television or radio in the room.

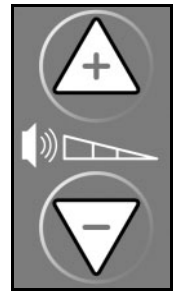

## Channel Control

The channel control allows the patient to change channels on the television or stations on the radio in the room.

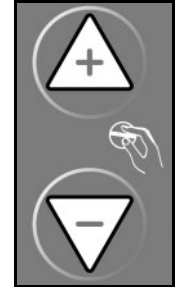

## Music Control

The music control allows the patient to turn on and off the radio in the room.



## Television Control

The television control allows the patient to turn on and off the television in the room.



## Accessories

Part Number	Description
P2217	IV Pole
P734EA1	Mattress foot pad extender
P158	Infusion Support System (ISS) transfer pole
P731EA3	Mattress
P27601	Oxygen tank holder, E-size
P163	ISS socket adapter
P1181	Traction frame support
P1180	Patient helper support

### IV Pole (P2217)

**⚠ CAUTION:**

Do not exceed the 25 lb (11 kg) load capacity of the IV pole. If the IV pole is overloaded, personal injury or equipment damage may occur.

**⚠ WARNING:**

If the IV pole is placed at the foot end of the bed, ensure the Knee Up/Down controls are locked out. Failure to do so can result in caregiver, patient, or visitor injury if the foot section fully lowers and the IV pole becomes dislodged from the bed.

**⚠ WARNING:**

The head end equipment sockets do not move up and down with the sleep deck. Use appropriate precautions with gravity-sensitive devices such as ventricular drains or lumbar drains before, during, and after operating bed functions. Make sure flow rates on all gravity-fed IVs are correct after bed height adjustment. Failure to correctly manage patient equipment could result in patient injury.

**⚠ CAUTION:**

When lowering the upper section of the IV pole, always grasp and hold the upper section of the pole before pulling the release knob.

The IV pole is a removable, telescopic pole that installs in any of the four equipment sockets on the bed. The IV pole can hold 25 lb (11 kg).

To install the standard IV pole, insert the IV pole into any of the four equipment sockets on the bed. Removal is reverse of installation.

**NOTE:**

Added height is recommended for gravity drain applications.



---

## Mattress Foot Pad Extender (P734EA1)

The mattress pad extender is used to fill in the gap between the mattress and the footboard when the foot section is extended to its full length.

### To Install

Insert the extender between the footboard and mattress after the foot section is extended.



---

## Infusion Support System Transfer Pole (P158)

### ⚠ WARNING:

If the ISS pole is placed at the foot end of the bed, ensure the Knee Up/Down controls are locked out. Failure to do so can result in caregiver, patient, or visitor injury if the foot section fully lowers and the ISS pole becomes dislodged from the bed.

### ⚠ CAUTION:

Do not exceed the 20 lb (9 kg) load capacity of the ISS pole. If the ISS pole is overloaded, personal injury or equipment damage may occur.

### ⚠ CAUTION:

Do not mount infusion pumps on the lower section of an IV pole. Doing so may cause interference with head section articulation.

### ⚠ CAUTION:

When lowering the upper section of an IV pole, always grasp and hold the upper section of the pole before pulling the release knob.

The Infusion Support System (ISS) consists of a movable and adjustable IV pole. The pole supports IV pumps or bags in a vertical orientation and raises or lowers the pumps or bags with respect to the system frame. The ISS pole can hold 20 lb (9 kg).

The head end of the system has attaching points for two mobile ISS. Each ISS can support one infusion pump plus two liters of intravenous solution.

When using the ISS, it is necessary to use the P163 socket adapter before installing the ISS pole.



---

## Mattress (P731EA3)

### ⚠ WARNING:

Only use mattresses of the specified dimension. Failure to do so could result in personal injury.

The mattress contains an all-foam, zoned, three-layered core with foam side bolsters and is designed to reduce patient interface pressures. The CareAssist™ Bed surface is designed especially for the CareAssist™ Bed frame. Loose fitting sheets (preferably knitted) must be used for correct operation of the sleep surface.

The CareAssist™ Bed surface is designed especially to work with the following system features:

- Shearless Pivot® Patient Position Mechanism
- FullChair® Patient Position Mechanism

Loose fitting sheets (preferably knitted) must be used for correct operation of the sleep surface.



---

## Oxygen Tank Holder, E-Size (P27601)

### ⚠ WARNING:

If the oxygen tank holder is placed at the foot end of the bed, ensure the Knee Up/Down controls are locked out. Failure to do so can result in caregiver, patient, or visitor injury if the foot section fully lowers and the holder becomes dislodged from the bed.

### ⚠ CAUTION:

Do not exceed the load capacity of the oxygen tank holder. If the oxygen tank is overloaded, personal injury or equipment damage may occur.

The oxygen tank holder attaches to the head end of the articulating frame in a vertical position. The oxygen tank holder accommodates one **E** size oxygen tank with a regulator. The mounting points are located to allow the affixed oxygen tank holder to pivot.



### To Install

- Install the mounting bar vertically into a mounting socket at either the head end or foot end of the articulating frame. Make sure the Knee Up/Down control is locked out if installing at the foot end.
- Place the tank in the holder, and tighten the holder thumbscrew. The thumbscrew keeps the oxygen tank from rotating in the holder.

### To Remove

- Loosen the thumbscrew that holds the tank secure in the holder.
- Lift the tank out of the holder.
- Lift up on the tank holder, and remove it from the mounting sockets.

---

## Traction Frame Support (P1181)

The traction frame adapter bracket (P1181) is to attach fracture frame equipment to the bed.

Refer to the equipment manufacturer's instructions for installation procedures.



---

## Patient Helper Support (P1180)

The Patient Helper Support (P1180) is used to attach the patient helper to the bed.

Refer to the equipment manufacturer's instructions for installation procedures



---

## Safety Tips

### Bed Positions

#### **⚠ WARNING:**

It is recommended that the unit be in the low position when the patient is unattended. This may reduce the severity of any resultant injuries from patient falls.

#### **⚠ WARNING:**

When a patient's condition (such as disorientation due to medication or clinical condition) could lead to patient entrapment, the sleep deck should be left in the flat and lowest position while unattended (except when required otherwise by medical staff for special or particular circumstances). Failure to do so could result in patient injury.

#### **⚠ WARNING:**

The head end equipment sockets do not move up and down with the sleep deck. Use appropriate precautions with gravity-sensitive devices such as ventricular drains or lumbar drains before, during, and after operating bed functions. Make sure flow rates on all gravity-fed IVs are correct after bed height adjustment. Failure to correctly manage patient equipment could result in patient injury.

### Brakes

#### **⚠ WARNING:**

Unless transporting the patient, always set the brakes when the unit is occupied. Reconfirm that the brakes are set before any patient transfer. Failure to do so may result in personal injury or equipment damage.

Brakes should always be set when the bed is occupied and especially when transferring a patient from one surface to another. Patients often use the bed for support when getting in and out of the bed and could be injured if the bed moves unexpectedly. After you set the brakes, push and pull the bed to make sure it is stable.

### Siderails/Restraints/Patient Monitoring

#### **⚠ WARNING:**

Evaluate patients for entrapment risk according to facility protocol, and monitor patients appropriately.

#### **⚠ WARNING:**

Evaluate patients for entrapment risk according to facility protocol, and monitor patients appropriately. Ensure that all siderails are fully latched when in the raised position. Failure to do either of these could result in serious injury or death.

#### **NOTE:**

Siderails are intended to be a reminder to the patient of the unit's edges, not a patient-restraining device. When appropriate, Hill-Rom recommends that medical personnel determine the proper methods necessary to ensure a patient remains safely in bed.

Siderails may serve several beneficial uses including providing an edge reminder, bed egress assist, and access to caregiver interface and patient controls. The use of siderails also may provide a sense of security. Siderails should always be in the upright and latched position when the CareAssist™ Bed is in

the chair position. The use of siderails in the bed position should be determined according to patient need after assessing any risk factors according to the facility protocols for safe positioning.

When raising the siderails, a **click** indicates that the siderails are completely raised and locked in place. Gently pull on the siderail once the **click** is heard to make sure the siderail is latched in position.

Siderails are intended to be a reminder, not a patient restraining device. Hill-Rom recommends that the appropriate medical personnel determine the level of restraint necessary to ensure a patient will remain safely in bed.

For restraining devices, consult the restraint manufacturer's instructions for use to verify the correct application of each restraining device.

**⚠ WARNING:**

Patient restraints are not intended as substitutes for good nursing practices. Physical restraints, even properly installed, can result in entanglement, physical injury, and death, particularly with agitated and disoriented patients. Monitor patients when using physical restraints in accordance with legal requirements and facility protocol.

1. Develop guidelines for all patients that indicate:

- Which patients may need to be restrained and the appropriate restraint to utilize.
- The proper method to monitor a patient, whether restrained or not, including time interval, visual check of restraint, etc.

2. Develop training programs for all caregivers concerning the proper use and application of restraints.

3. Maintain the bed at its lowest position whenever a caregiver is not in the room.

4. Clarify the need for restraint devices to families or guardians.

**Electricity**

**⚡ SHOCK HAZARD:**

The potential for electrical shock exists with electrical equipment. Failure to follow facility protocols may result in death or serious personal injury.

**⚠ WARNING:**

Do not expose the unit to excessive moisture. Personal injury or equipment damage could occur.

**⚠ WARNING:**

Improper use or handling of the power cord may result in damage to the power cord. If damage has occurred to the power cord or any of its components, immediately remove the unit from service, and contact the appropriate maintenance personnel. Failure to do so could result in personal injury or equipment damage.

**⚠ WARNING:**

If the integrity of the external protective earth conductor is in doubt, operate the bed from its internal electrical power source. Failure to do so could result in personal injury.

**⚠ CAUTION:**

This device meets all applicable requirements for electromagnetic compatibility per IEC 60601-1-2. It is unlikely that the user will encounter problems with this device because of inadequate electromagnetic immunity. However, electromagnetic immunity is relative, and standards are based on anticipated environments of usage. If the user notes unusual device behavior, particularly if such behavior is intermittent and associated with nearby usage of radio or TV transmitters, cell phones, or electro-surgical equipment, this could be an indication of electromagnetic-interference. If such behavior occurs, the user should try moving the interfering equipment further from this device.

**⚠ CAUTION:**

Before transporting the unit, ensure that the power cord is properly stored. Failure to do so could result in equipment damage.

Policies and procedures must be established to train and educate your staff on the risks associated with electric equipment. It is never prudent or necessary for personnel to place any part of their body under or between moving parts of the bed. Whenever a bed is being cleaned or serviced, it should be unplugged from its power source, and the lockouts should be activated to keep the bed from accidentally operating due to the battery backup.

**Parts and Accessories**

Only use parts and accessories from Hill-Rom. Do not modify the bed system without authorization from Hill-Rom.

**Operating Bed/Surface Precautions**

**⚠ WARNING:**

Do not operate the bed in the presence of flammable gas or vapors. Doing so could result in personal injury or equipment damage.

**⚠ WARNING:**

Use oxygen administering equipment of the nasal, mask, or ventilator type only. Do not use with oxygen tents. Doing so could result in personal injury or equipment damage.

**⚠ WARNING:**

Deactivate the bed functions by using the lockout control. Movement of a patient or inadvertent activation of the bed functions by untrained individuals could result in personal injury.

**Transport**

**⚠ WARNING:**

Do not store the power cord in the holes in the headboard. Doing so may result in entanglement problems with the headboard while removing the headboard during emergency CPR.

The CareAssist™ Bed is intended to be used to transport patients with the foot end of the system forward. Prior to transport, properly stow the power cord to prevent tripping. Take care to prevent damage to the AC power cord. An electrical shock hazard exists. Use only the headboard or the footboard to move the bed.

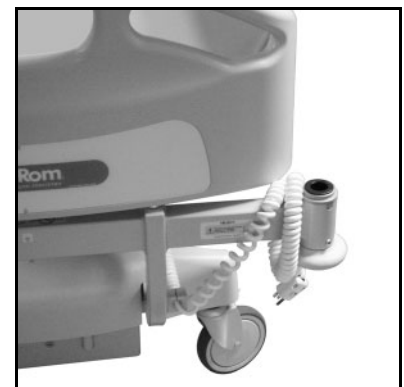

Make sure that the patient, equipment, and all lines are securely placed within the perimeter of the bed for intra-hospital transport. The CareAssist™ Bed is not intended to be used to transport a patient in the Dining Chair™ Position or FullChair® Patient position.

Fully extended IV poles could impact doorways or ceiling fixtures. Lower poles prior to patient transport.

Make sure the Nurse Call system cables are properly connected after transport.

### **Sleep Surface/Mattress**

#### **⚠ WARNING:**

Some safety features of the CareAssist™ Bed may not function or may not operate as intended with surfaces manufactured by other companies. Check with the surface manufacturer to determine those safety features of the bed that have been tested and verified to work properly with the replacement surface. Failure to do so could result in serious personal injury or damage to equipment.

#### **NOTE:**

Hill-Rom recommends the use of Hill-Rom surfaces that have been designed and tested specifically for the CareAssist™ Bed. Customers electing to purchase replacement surfaces from other manufacturers should confirm that the replacement surface, when used in conjunction with the CareAssist™ Bed, meets applicable regulations, regulatory guidance and technical standards and does not create unacceptable risks of injury to patients or caregivers. Specifically, Hill-Rom suggests that surfaces utilize dimensions and construction to minimize gaps where entrapment could occur, provide for sufficient height between the surface and the top of the siderail to prevent accidental roll-over events, provide appropriate firmness at the edges of the surface to facilitate safe transfers into and out of the bed, and do not interfere with the proper operation of siderails.

#### **⚠ WARNING:**

Sleep surface impermeability could be affected by needle sticks or punctures caused by improper use of x-ray cassette holders and/or needle sticks. Personal injury or infection could result.

The sleep surface should be regularly inspected for such damage.

### **Flammability**

#### **⚠ WARNING:**

Patients should not be allowed to smoke in bed. Sheets and pillows generally do not have flame resistant properties. Personal injury or equipment damage could occur.

Reduce the possibility of fires by observing fire prevention rules and regulations.

The sleep surface mattress meets the following specifications:

- CAL TB-117, *Requirements, Test Procedure and Apparatus for Testing the Flame Retardance of Resilient Filling Materials Used in Upholstered Furniture* (foam)
- 16 CFR 1632, *Standard for the Flammability of Mattresses and Mattress Pads*
- CAL TB-129, *Flammability Test Procedures for Mattresses for Use in Public Buildings* (models with fire barrier only)
- BFD IX-II, *Boston Fire Department Mattress Fire Test* (models with fire barrier only)

## **Bed Articulations**

Do not operate system controls until all persons and equipment are clear of mechanisms. To stop a function do any or all of the following:

- Release the control.
- Activate the opposite function.
- Immediately unplug the power cord.

Observe lines closely during articulations. Always use good line management techniques, particularly as the head section rises.

## **Chair Positioning**

Always set the brakes before placing the system in a chair position. Observe lines closely during head up/down and chair articulation.

## **Visitor Notification**

Instruct visitors not to attempt operation of the caregiver siderail controls. Visitors may assist the patient with patient controls.

---

## Cleaning

### **WARNING:**

Follow the product manufacturer's instructions. Failure to do so could result in personal injury or equipment damage.

### **SHOCK HAZARD:**

Unplug the unit from its power source. Failure to do so could result in personal injury or equipment damage.

### **SHOCK HAZARD:**

Do not expose the unit to excessive moisture. Personal injury or equipment damage could occur.

### **SHOCK HAZARD:**

The potential for electrical shock exists with electrical equipment. Failure to follow facility protocols may result in death or serious personal injury.

### **CAUTION:**

Do not use harsh cleansers, solvents, or detergents. Equipment damage could occur.

---

## General Cleaning

We recommend that you clean the unit with detergent and warm water. Do not use excessive liquid or harsh cleansers.

---

## Steam Cleaning

Do not use any steam cleaning device on the unit or immerse in water. Excessive moisture can damage mechanisms in this unit.

---

## Cleaning Hard to Clean Spots

To remove difficult spots or stains, we recommend that you use standard household cleansers and a soft bristle brush. To loosen heavy, dried-on soil, you may first need to saturate the spot.

---

## Disinfecting

When there is visible soilage and also between patient use, we recommend that you disinfect the unit using an EPA registered (US only), tuberculocidal, disinfectant.

Dilute and use the disinfectant as specified on the manufacturer's label.

---

## Preventive Maintenance

### **⚠ WARNING:**

Only facility-authorized personnel should service the CareAssist™ Bed. Servicing by unauthorized personnel could result in personal injury or equipment damage.

The CareAssist™ Bed requires an effective maintenance program. We recommend that you perform annual preventive maintenance (PM) and testing for Joint Commission on Accreditation of Healthcare Organizations (JCAHO). PM and testing not only meet JCAHO requirements but will help ensure a long, operative life for the CareAssist™ Bed. PM will minimize downtime due to excessive wear. For preventive maintenance schedule, refer to the [CareAssist™ Bed Service Manual \(MAN330\)](#).

Perform annual preventive maintenance procedures to ensure all CareAssist™ Bed components are functioning as originally designed. Pay particular attention to safety features, including but not limited to the following:

- Siderail latching mechanisms
- Caster braking systems
- Electrical system components
- Electrical power cords for fraying, damage, and proper grounding
- Leakage current at the Nurse Call system communication connections
- Controls return to off or neutral position when released
- Cables are not tangled in system mechanisms or siderails
- Proper operation of the lockout controls
- Integrity of sleep surface ticking
- Proper operation of the scale and Bed Exit System

### **The CareAssist™ Bed Main Battery**

Replace the battery if any of the following conditions exist (refer to the [CareAssist™ Bed Service Manual \(MAN330\)](#)):

- The battery indicator does not stop flashing (low condition) within 12 hours of bed connection to the AC power
- The battery completely discharges when less than three (3) complete hilot cycles with no load on the bed (no patient on the surface) are completed .

### **Troubleshooting**

### **⚠ WARNING:**







Only facility-authorized personnel should troubleshoot the CareAssist™ Bed. Troubleshooting by unauthorized personnel could result in personal injury or equipment damage.







Always check the battery charge status on the siderail. The bed may not be functioning due to the battery being drained and the bed needing to be plugged into an appropriate power source.







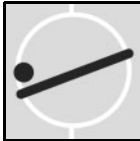



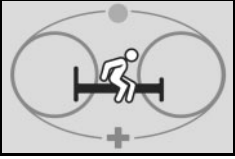



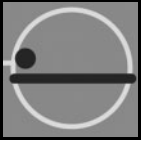

## Product Symbols





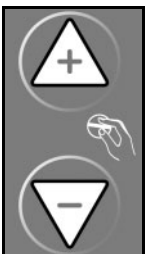

The following symbols are used on the CareAssist™ Bed:





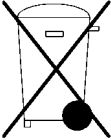

Symbol	Description
	<p>Type B applied part according to IEC 60601-1 (UL 60601-1).</p>
<p><b>IPX4</b></p>	<p>According to IEC 60529, Rating for protection against fluid ingress and identified as equipment that is protected against spraying and splashing water.</p>
	<p>CAUTION: Consult accompanying documents.</p>
<p><sup>a</sup></p> 	<p>Medical Electrical Equipment Classified By Underwriters Laboratories Inc. with respect to Electric Shock, Fire, and Mechanical Hazards only in accordance with UL60601-1, IEC60601-1, CAN/CSA C22.2 No 601.1, and IEC60601-2-38.</p>
	<p>Demko Certified Unit.</p>
	<p>Lockout control—Used to lockout or unlock bed functions.</p>
	<p>Bed Up/Down control—Raises and lowers the bed.</p>



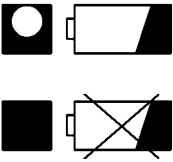
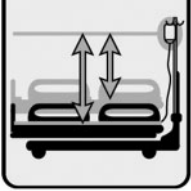

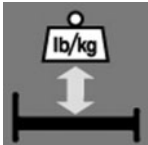



Symbol	Description
	<p>Head Up/Down control—Raises and lowers the head section of the bed.</p>
	<p>Knee Up/Down control—Raises and lowers the knee section of the bed.</p>
	<p>Battery control—Activates the battery. Indicates battery charge.</p>
	<p>Enable control—Enables the Trendelenburg and Reverse Trendelenburg functions on the bed. (Located on the caregiver control panel)</p>
	<p>Enable control—<b>Only</b> enables the Bed Exit System control pod functions. (Located on the scale control pod)</p>
	<p>Trendelenburg control—Enables the Trendelenburg function on the bed.</p>
	<p>Reverse Trendelenburg control—Enables the Reverse Trendelenburg function on the bed.</p>





Symbol	Description
	<p>Bed Exit control—Arms and disarms the Bed Exit function on the bed. (Beds without scale)</p>
	<p>Nurse Call control—Sends a Nurse Call to the nurse's station when activated.</p>
	<p>Hip Location—Indicates optimal patient placement on the bed.</p>
	<p>Dining Chair™ Position control—Enables the Dining Chair™ Position function on the bed.</p>
	<p>Bed Flat control—Places the bed in a flat position.</p>
	<p>Foot Up control—Raises the foot section on the bed.</p>
	<p>Foot Down control—Lowers the foot section on the bed.</p>
	<p>Room Light control—Turns the room light on and off. (Patient control pendant only)</p>

Symbol	Description
	<p>Reading Light control—Turns the reading light on and off. (Patient control pendant only)</p>
	<p>Music control—Turns the radio on and off. (Patient control pendant only)</p>
	<p>Television control—Turns the television on and off. (Patient control pendant only)</p>
	<p>Volume control—Raises or lowers the volume of the television or radio. (Patient control pendant only)</p>
	<p>Channel/Station Up/Down control—Changes the television channel or radio station up or down. (Patient control pendant only)</p>
	<p>Steer Indicator—Indicates the position needed for the brake/steer bar to be located in for the bed to have steer function.</p>
	<p>Neutral Indicator—Indicates the position needed for the brake/steer bar to be located in for the bed to have neutral function.</p>

Symbol	Description
	Brake Indicator—Indicates the position needed for the brake/steer bar to be located in for the brakes to be set.
	Do not store items in this area.
	Recycle—Indicates an item that is a recyclable item.
	Do Not Throw Away—Indicates the need to recycle the item.
	Do Not Use with Oxygen Tents—Indicates that oxygen tents are not to be used. Use oxygen administering equipment of the nasal, mask, or ventilator type only.
	Bed Not Down Indicator—Illuminates when the bed is not in the low-low position.
	Safe Working Load—Indicates the safe working load of the bed.

Symbol	Description
	<p>Battery present—Indicates the presence of a battery in the bed.</p>
	<p>Shows the head end IV poles do not change height when the sleep surface is raised or lowered.</p>
	<p>Bed Exit control—Arms and disarms the Bed Exit function on the bed. (B model beds with scale only)</p>
	<p>Change Items indicator—Beds with scale</p>
	<p>Change Items control—Beds with scale</p>
	<p>Weigh control—Beds with scale</p>
	<p>Plus and Minus arrows—For manually adjusting the patient weight.</p>
	<p>Local Alarm Volume control—B model beds with scale only.</p>

Symbol	Description
	Local Alarm Tone control—B model beds with scale only.
	Zero control—Beds with scale
	Hands Off indicator—Beds with scale
	Patient Position Mode/Patient Movement Mode alarm—Comes on when a patient moves towards either siderail or moves away from the head section such as by sitting up in bed (C model and newer beds).
	Bed Exiting Mode alarm—Comes on when a patient moves away from the center of the bed towards an exit point (C model and newer beds).
	Out-of-Bed Mode alarm—Comes on when the patient's weight shifts significantly off the frame of the bed (C model and newer beds).
	Alarm Silence control—Silences the Bed Exit Alarm (C model and newer beds).
	Alarm Volume indicator—Shows the local alarm volume level setting of the Bed Exit Alarm System (C model and newer beds).

Symbol	Description
	<p>Empty bed—Reminder to make sure the patient is not on the bed when you zero the scale.</p>
	<p>Bed Exit Alarm System Zero control—Zeroes the Bed Exit Alarm System on beds without a scale. (C model and newer beds only)</p>
	<p>Bed Exit Alarm System Deactivation Instruction—Shows the sequence to deactivate the Bed Exit Alarm System.</p>
	<p>Service Required indicator—Flashes to show a Bed Exit System malfunction (beds without scale ) (C model and newer beds only)</p>

a. The UL logo is a registered trademark of Underwriter's Laboratories, Inc.



# Specifications

## Product Identification

Product Number	Description
P1170	The CareAssist™ Bed

## Dimensions

Feature	Dimension
Total length	100" (254 cm)
Maximum width (siderails stored)	40" (102 cm)
Maximum width (siderails up)	40" (102 cm)
Recommended Mattress dimensions:	
Mattress width	36.25" (92.1 cm)
Mattress length	80.0" (203.2 cm)
Mattress thickness	6.0" (15.2 cm)
Alternate mattresses: Recommended height above the mattress at the deck perimeter to the top of the siderail, per IEC 60601-2-38	8.7" (220 mm)
Caster size	6.0" (15.2 cm)
Total weight	420.0 lb (190.5 kg) without surface, options, or accessories

## Specifications

Feature	Dimension
Head section inclination (maximum)	65°
Knee section inclination (maximum)	20°
Foot section inclination (maximum)	-23°
Maximum height (to top of sleep deck)	32.5" (82.5 cm)
Minimum height (to top of sleep deck)	16.75" (42.54 cm)
Trendelenburg position (maximum)	16°
Safe working load (safe working load includes: patient, accessories, mattress, and etc.)	400 lb (181 kg)
Siderail opening size	4.34" (11.02 cm)
Distance between siderails	< 2.3" (58.4 mm)

## Environmental Conditions for Transport and Storage

Condition	Range
Temperature	-40°F to 122°F (-40°C to 50°C)
Relative humidity	Up to 95%, non-condensing
Pressure	50 kPa to 106 kPa

### Nurse Call Connection Requirements

For information about the Nurse Call connection requirements, refer to the *SideCom® Communication System Design and Application Manual (DS059)*.

#### Environmental Conditions for Use

Condition	Range
Temperature	32°F to 104°F (0°C to 40°C) ambient temperature
Relative humidity range	30% to 85% non-condensing
Atmospheric Pressure	70 kPa to 106 kPa

#### AC Power Requirements

Nominal Power Distribution Voltage (Volts)	Nominal Power Distribution Frequency (Hertz)	Maximum Equipment Current (Amps)
120	60	6.0 <sup>a</sup>
100	50/60	7.5
110-120	50/60	7.5
127	50/60	6.0
220	50/60	3.5
230	50/60	3.5
240	50/60	3.5

a. North American power supply configuration.

#### Fuse Specifications

There are no user accessible fuses. Refer to the *CareAssist™ Bed Service Manual (MAN330)* for fuse ratings and replacement procedures.

## Classification and Standards

The CareAssist™ Bed is designed and manufactured according to the following equipment classifications and standards:

Technical and Quality Assurance Standards	UL 60601-1 CSA® C22.2 No. 601.1 IEC 60601-2-38 IEC 60601-1 IEC 60601-1-2 EN ISO 9001 and EN 13485
Equipment Classification per IEC 60601-1	Class I equipment, internally powered equipment
Degree of Protection Against Electric Shock	Type B
Degree of Protection Against Ingress of Water	Protection against spraying or splashing water- IPX4
Degree of Protection Against the Presence of Flammable Anaesthetic Mixtures	Not for use with flammable anaesthetics.
Mode of Operation	Continuous operation with intermittent loading, 3 minutes ON/27 minutes OFF
Sound level (except alarms) (measured 1 meter from patient's ear)	< 60 dBA

a. CSA® is a registered trademark of Canadian Standards Association, Inc.

## Electromagnetic Emissions Guidance

<b>Guidance and Manufacturer's Declaration—Electromagnetic Emissions</b>		
The CareAssist™ Bed model P1170 is intended for use in the electromagnetic environment specified below. The customer or the user of the model P1170 should make sure it is used in such an environment.		
<b>Emissions Test</b>	<b>Compliance</b>	<b>Electromagnetic Environment—Guidance</b>
RF Emissions CISPR 11	Group 1	The model P1170 uses RF energy only for its internal functions. Therefore, its RF emissions are low and are not likely to cause any interference in nearby electronic equipment.  The model P1170 is suitable for use in all establishments other than domestic and those directly connected to the public low-voltage power supply network that supplies buildings used for domestic purposes.
RF Emissions CISPR 11	Class A	
Harmonic Emissions IEC 61000-3-2	Not Applicable	
Voltage Fluctuations/ Flicker Emissions IEC 61000-3-3	Not Applicable	

## Electromagnetic Immunity Guidance

<b>Guidance and Manufacturer's Declaration - Electromagnetic Emissions</b>			
The CareAssist™ Bed model P1170 is intended for use in the electromagnetic environment specified below. The customer or the user of the model P1170 should make sure it is used in such an environment.			
<b>Immunity Test</b>	<b>IEC 60601 Test Level</b>	<b>Compliance Level</b>	<b>Electromagnetic Environment— Guidance</b>
Electrostatic Discharge (ESD) IEC 61000-4-2	± 6kV Contact ± 8kV Air	± 6kV Contact ± 8kV Air	Floors should be wood, concrete, or ceramic tile. If floors are covered with synthetic material, the relative humidity should be at least 30%.
Radiated RF IEC 61000-4-3	3 Vrms 80 MHz to 2.5 GHz	3 Vrms 80 MHz to 2.5 GHz	Portable and mobile RF communications equipment should not be used at close distances to the P1170 bed. (See Note 2)
Electrical Fast Transient/Burst IEC 61000-4-4	± 2kV on Power Supply Lines ± 1kV on Input/ Output Lines	± 2kV on Power Supply Lines ± 1kV on Input/ Output Lines	Mains power quality should be that of a typical commercial or hospital environment
Surge IEC 61000-4-5	± 1kV Differential Mode (line-line) ± 2kV Common Mode (Line-Ground)	± 1kV Differential Mode (line-line) ± 2kV Common Mode (Line-Ground)	Mains power quality should be that of a typical commercial or hospital environment
Conducted RF IEC 61000-4-6	3 Vrms 150 kHz to 80 MHz	3 Vrms 150 kHz to 80 MHz	Portable and mobile RF communications equipment (cell phones) should not be used at close distances to the P1170 bed. (See Note 2)
Power Frequency Magnetic Fields IEC 61000-4-8	3 A/m	3 A/m	The power frequency magnetic field should be measured in the intended installation location to assure it is sufficiently low.
Voltage Dips, Short Interrupts, & Variations On Power Supply Lines IEC 61000-4-11	< 5% $U_T$ (95% dip in $U_T$ for 0.5 cycles ) < 40% $U_T$ (60% dip in $U_T$ for 5 cycles ) < 70% $U_T$ (30% dip in $U_T$ for 25 cycles ) < 5% $U_T$ (95% dip in $U_T$ for 5 seconds ) (See Note 1)	< 5% $U_T$ (95% dip in $U_T$ for 0.5 cycles ) < 40% $U_T$ (60% dip in $U_T$ for 5 cycles ) < 70% $U_T$ (30% dip in $U_T$ for 25 cycles ) < 5% $U_T$ (95% dip in $U_T$ for 5 seconds )	Mains power quality should be that of a typical commercial or hospital environment. If operation is required during an extended power outage or interruption, the model P1170 should be switched to operate from the backup battery.
Note 1: $U_T$ is the AC mains voltage prior to application of the test level.			
Note 2: The compliance levels in the ISM frequency range 150 kHz to 2.5 GHz are intended to decrease the likelihood that mobile/portable communications equipment could cause interference if it is inadvertently brought into the patient area. However, emission limits, IEC 60601 test levels, and tests specified in IEC 60601-1-2:2001 do not address electromagnetic compatibility of electrical equipment at very close distances. Care should always be exercised when using any electrical or RF equipment in the immediate patient area.			



**USA Rental Therapy**  
Hill-Rom Company, Inc.  
4349 Corporate Road  
Charleston, SC 29405  
Tel: 800-638-2546

**St. Paul, MN USA**  
Hill-Rom Company, Inc.  
1020 W. County Road F  
St. Paul, MN 55126  
Tel: 651-490-1468 or 800-426-4224  
www.thevest.com

**Belgique / België**  
Distribal  
Admiral De Boisot Straat 19-21  
2000 Antwerpen  
Tel: +32 (0)32 38 43 15  
Fax: +32 (0)32 16 06 86

**Canada**  
Hill-Rom Canada  
5444 Timberlea Blvd.  
Mississauga, Ontario  
Canada L4W 2T7  
Tel: 800-267-2337

**Deutschland**  
Hill-Rom GmbH  
Franz-Rennefeld-Weg 4  
40472 Dusseldorf  
Tel: +49 (0)211 16450 0  
Fax: +49 (0)211 16450 182

**Ellás**  
Meditime  
Nikolaos Chatziioannidis  
Egnatia 142 Str  
54622 Thessaloniki  
Tel: +30 2310 263300  
Fax: +30 2311 263329

**España**  
Hill-Rom Iberia S.L.  
C/ Comerc, n° 2-22, Nave n° 14  
Poligno Industrial EL PLA  
08980 Sant Feliu de Llobregat  
(Barcelona) - SPAIN  
Tel: +34 (0)93 685 6009  
Fax: +34 (0)93 666 5570

**France**  
Hill-Rom SAS  
Z.I. du Talhouët, BP 14  
56330 Pluvigner  
Tel: +33 (0)2 97 50 92 12  
Service France: +33 (0)820 01 23 45  
Fax: +33 (0)2 97 50 92 00

**Ireland**  
Hill-Rom Ltd.  
Unit 1 - Kilcarberry Business Park  
Nangor Road  
Dublin 22  
Tel: +353 (0)1 413 6005  
Fax: +353 (0)1 413 6030  
dublin.sales@hill-rom.com

**Italia**  
Hill-Rom S.p.A.  
Via Ambrosoli 6  
20090 Rodano  
Tel: +39 (0)02 / 950541  
Fax: +39 (0)02 / 95328578

**Nederland**  
Hill-Rom Medical Services BV  
Hagenweg 1c  
Postbus 173  
4130 ED Vianen  
Tel: +31 (0)347 / 32 35 32  
Fax: +31 (0)347 / 32 35 00

**Nordic Region**  
Hill-Rom AB  
Ekbacksvägen 20  
168 69, Bromma  
Sweden  
Tel: +46 (0)8 564 353 60  
Fax: +46 (0)8 564 353 61  
se.marketing@hill-rom.com

**Österreich**  
Hill-Rom Austria GmbH  
Bueropark Donau / Haus 8  
3400 Klosterneuburg  
Tel: +43 (0)2243 / 28550  
Fax: +43 (0)2243 / 28550-19  
austria@hill-rom.com

**Portugal**  
Hill-Rom Iberia S.L.  
C/ Comerc, n° 2-22, Nave n° 14  
Poligno Industrial EL PLA  
08980 Sant Feliu de Llobregat  
(Barcelona) - SPAIN  
Tel: +34 (0)93 685 6009  
Fax: +34 (0)93 666 5570

**Suisse / Schweiz**  
Hill-Rom SA  
Chemin du Vallon 26  
1030 Bussigny  
Tel: +41 (0)21 / 706 21 30  
Fax: +41 (0)21 / 706 21 33  
hrch.info@hill-rom

**United Kingdom**  
Hill-Rom Ltd.  
Clinitron House  
Ashby Park  
Ashby de la Zouch  
Leicestershire LE65 1JG  
Tel: +44 (0)1530 411000  
Fax: +44 (0)1530 411555

**International**  
Hill-Rom Company, Inc.  
International Department  
1069 State Route 46 East, J55  
Batesville, Indiana 47006 USA  
Tel: +1 (0)812 934 8173  
Fax: +1 (0)812 934 7191  
www.hill-rom.com  
international@hill-rom.com

---